

## GCSE (9–1) Mathematics

J560/03 Paper 3 (Foundation Tier)

**Monday 12 November 2018 – Morning**

**Time allowed: 1 hour 30 minutes**



**You may use:**

- a scientific or graphical calculator
- geometrical instruments
- tracing paper



First name										
Last name										
Centre number						Candidate number				

### INSTRUCTIONS

- Use black ink. You may use an HB pencil for graphs and diagrams.
- Complete the boxes above with your name, centre number and candidate number.
- Answer **all** the questions.
- Read each question carefully before you start to write your answer.
- Where appropriate, your answers should be supported with working. Marks may be given for a correct method even if the answer is incorrect.
- Write your answer to each question in the space provided. If additional space is required, use the lined page(s) at the end of this booklet. The question number(s) must be clearly shown.
- Do **not** write in the barcodes.

### INFORMATION

- The total mark for this paper is **100**.
- The marks for each question are shown in brackets [ ].
- Use the  $\pi$  button on your calculator or take  $\pi$  to be 3.142 unless the question says otherwise.
- This document consists of **24** pages.

Answer **all** the questions.

- 1 In a survey, people were asked to choose their favourite type of pizza.  
The pictogram shows some of the results.

8 people chose Margherita.



Margherita	
Pepperoni	
Napolitana	
Veggie	
Hawaiian	

Key:  represents ..... people.

- (a) Complete the key. [1]

- (b) How many people chose Pepperoni?

(b) ..... [1]

- (c) There were 36 people in the survey.  
All of these people chose one of the pizzas in the pictogram.

Complete the pictogram for Veggie. [3]



2 Work out.

$$5 \times (2 + 4)$$

..... [1]



3 (a) Write  $\frac{3}{8}$  as a decimal.

(a) ..... [1]

(b) Write 42% as a fraction.  
Give your answer in its simplest form.

(b) ..... [2]

4 Tia thinks of a number.  
She finds the square root and subtracts 4.  
Her answer is 1.

What number is she thinking of?



..... [2]

- 5 A fair spinner has five sides.  
Each side is labelled **A** or **B**.

This diagram shows a probability scale.

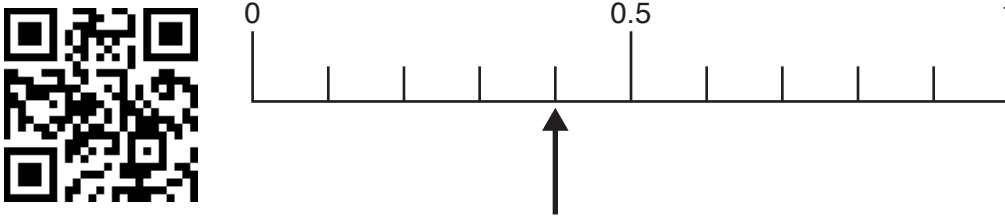

The arrow shows the probability that the spinner lands on an **A**.

- (a) Circle the word that best describes this probability.

Likely

Impossible

Unlikely

Certain

[1]

- (b) Here is the spinner with two sides labelled.

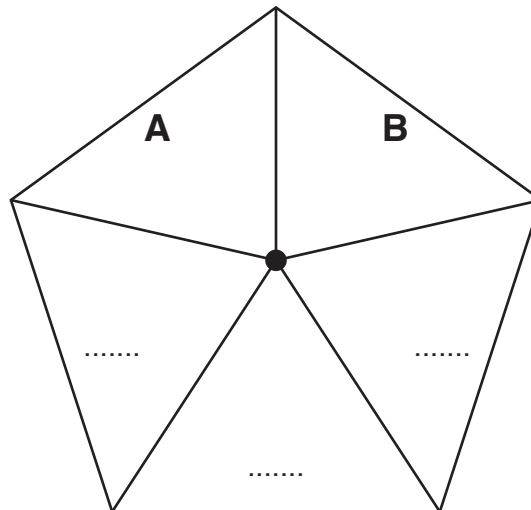

Label the other sides with **A** or **B** to give the correct probability of landing on an **A**.

[2]



6 Write the following in order of size, starting with the smallest.

0.41      0.403      0.438      0.4374

..... [2]  
*smallest*

7 (a) Show the inequality  $x > 3$  on this number line.

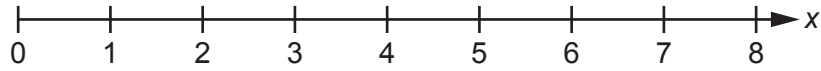

[2]

(b) Simplify.

$$4a + 3c + 7a - 5c$$

(b) ..... [2]

(c) Solve.

$$\frac{2x}{3} = 4$$

(c)  $x =$  ..... [2]

- 8 This table shows the ticket price for each person to visit a zoo in winter.

Type of ticket	Ticket price
Adult (aged 18 and over)	£18
Child (aged 3 to 17)	£14
Child (aged below 3)	Free

- (a) A family of two adults, one child aged 8 and one child aged 1 visit the zoo in winter.

What is the total cost of the tickets?



(a) £ ..... [2]

- (b) In summer, the zoo increases the prices.

An Adult ticket increases by 20%.  
A Child ticket increases by 15%.

How much more does it cost the family to visit in the summer than in the winter?

(b) £ ..... [4]

- 9 Danisha is going to visit two of these places.

London Eye (LE)    Buckingham Palace (BP)    Tower of London (TL)    British Museum (BM)

- (a) List all the combinations of these places that she can visit.  
One combination is already shown in the table.  
You may not need all the rows.



LE	BP

[2]

- (b) What fraction of the combinations include the London Eye (LE)?

(b) ..... [1]

10 Here are two identical tiles.

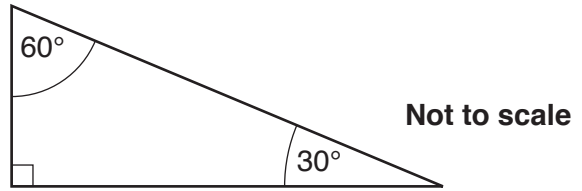
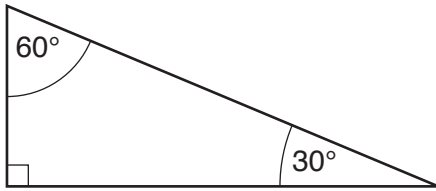

(a) Sketch two quadrilaterals that can be made by joining the tiles.  
Write the mathematical name of each quadrilateral.

Quadrilateral 1:

Quadrilateral 2:



Name: .....

Name: ..... [4]

(b) The two tiles can also be joined to make two triangles.

Work out the interior angles of each triangle.

(b) Triangle 1: .....° .....° .....°

Triangle 2: .....° .....° .....°

[2]





11 Gill uses the formula

$$h = 2fg$$

(a) Find the value of  $h$  when  $f = 1$  and  $g = 3$ .

(a)  $h = \dots\dots\dots$  [1]

(b) Find the value of  $g$  when  $h = 18$  and  $f = 6$ .

(b)  $g = \dots\dots\dots$  [2]

12 Fill in each missing number.

(a)  $0.36 \times 20 = \dots\dots\dots \times 10$  [1]

(b)  $14 \div 50 = \dots\dots\dots \div 100$  [1]



13 (a) Work out  $2^4$ .



(a) ..... [2]

(b) Find the value of  $n$ .

$$100 = 4 \times 5^n$$

(b)  $n =$  ..... [2]

14 30 people choose their favourite sport.  
 Matt wants to show their choices in a pie chart.  
 4 of the people chose 'tennis'.

Work out the angle of the sector for 'tennis'.



.....° [3]

15 Using ruler and compasses only, construct the perpendicular bisector of FG.

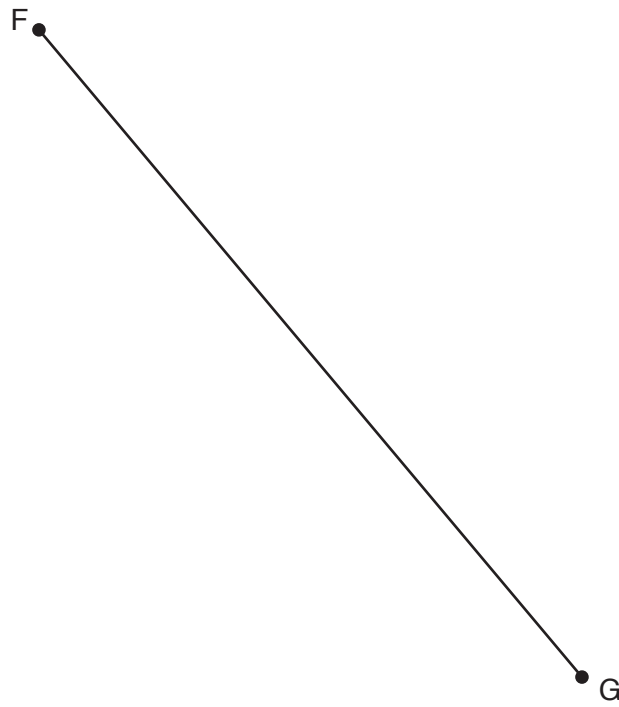

[2]

- 16 In a dance competition, two judges each award scores out of 30.  
The scatter diagram shows the scores awarded to the first 10 dancers.

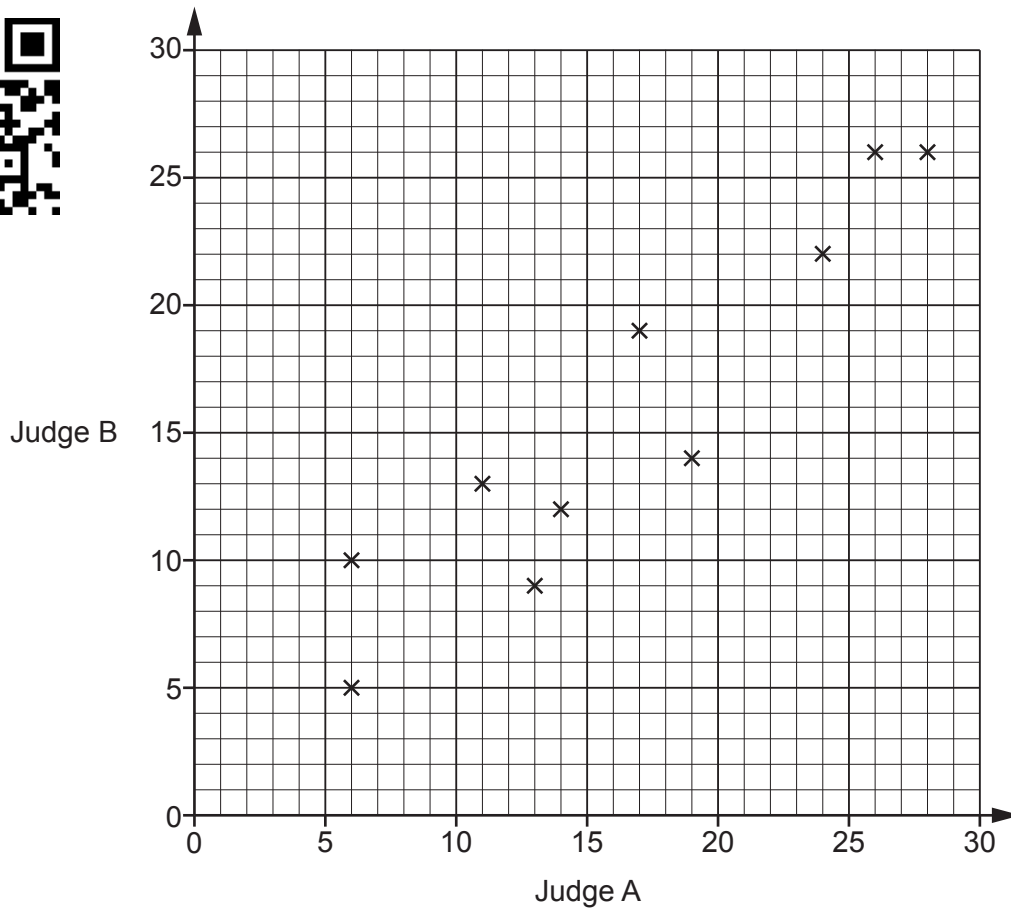

- (a) Here are the scores for the next two dancers.

Judge A	21	7
Judge B	18	8

Plot their scores on the scatter diagram.

[1]

(b) Dancers who are awarded a score of more than 20 by **both** judges receive a medal.

For the 12 dancers, express the ratio of medal winners to non-medal winners in its simplest form.

(b) ..... : ..... [3]

(c) This chart shows the types of dance performed by the 12 dancers.

3 performed a street dance, 8 performed a jazz dance and 1 performed a tap dance.

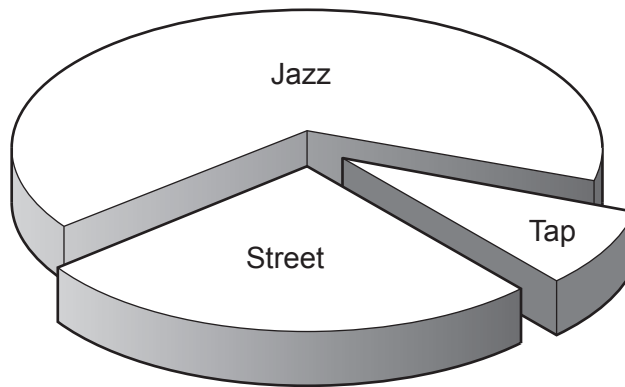

Why is this diagram misleading?

.....  
.....  
..... [1]

17 The police record the speed of vehicles passing a speed checkpoint.  
The speeds are recorded in the table below.



Speed ( $s$ mph)	Number of vehicles		
$0 < s \leq 20$	5		
$20 < s \leq 40$	8		
$40 < s \leq 50$	37		
$50 < s \leq 60$	47		
$60 < s \leq 80$	3		

(a) Calculate an estimate of the mean speed of the vehicles.

(a) ..... mph [4]

(b) Explain why it is not possible to use the information from this table to calculate the **exact** value of the mean speed.

.....  
 .....  
 ..... [1]

- 18 The diagram shows a square, a regular hexagon and part of another regular polygon meeting at point P.

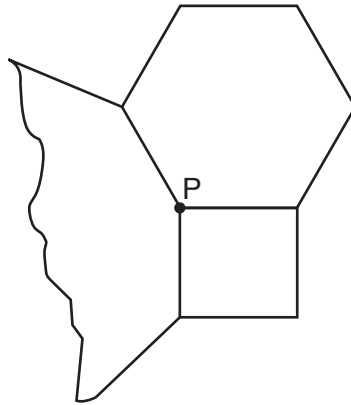

Not to scale

- (a) Show that the size of one interior angle of a regular hexagon is  $120^\circ$ . [2]

- (b) Find the number of sides of the other regular polygon.

(b) ..... [4]

19 (a) This graph shows part of a straight line.

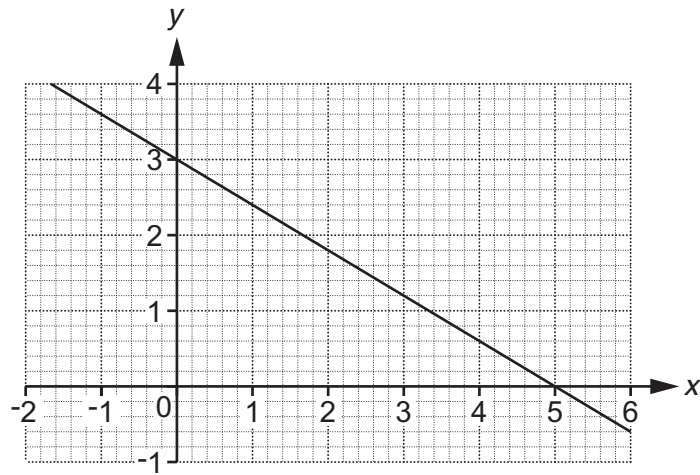

Write down the  $y$ -intercept.

(a) ..... [1]



(b) This graph shows part of another straight line.

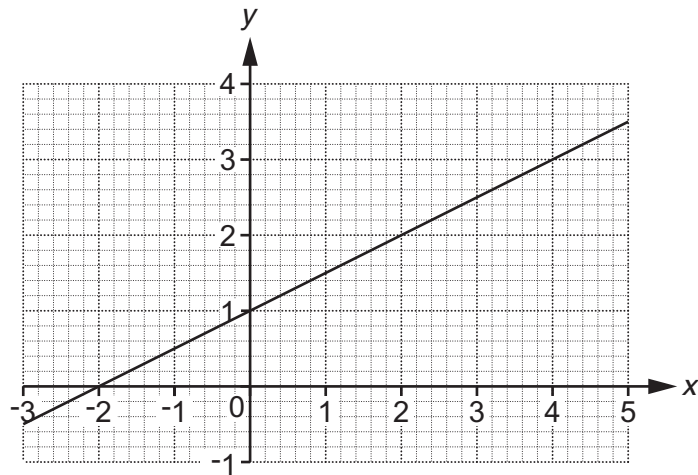

(i) Find the gradient of this line.

(b)(i) ..... [2]

(ii) This line is continued to the right.

Will the line pass through the point (200, 102)?  
Show how you decide.

..... [3]

20 A bee flies from its hive to a flower at a constant speed of 7.5 metres per second for 10 seconds. The bee then takes 15 seconds to fly back to the hive. Assume the bee always flies in a straight line.

(a) Ignoring the time spent at the flower, work out the **overall** average speed of the bee in its flight from the hive to the flower and back.



(a) ..... metres per second [4]

(b) If the bee is not assumed to fly in a straight line, how might your answer be affected?

.....  
 ..... [1]

21 Here is a right-angled triangle.

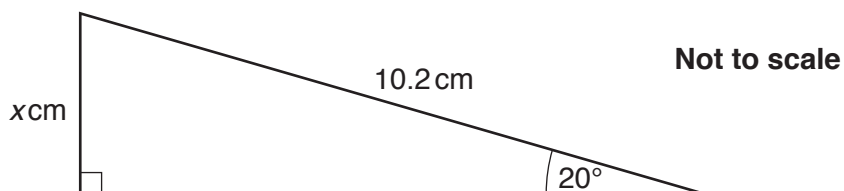

Use trigonometry to work out the value of  $x$ .

$x =$  ..... [3]



22 A newborn baby has an approximate mass of 3.5 kilograms.

A human cell has an approximate mass of  $2.7 \times 10^{-11}$  grams.

Use these values to estimate the number of human cells in a newborn baby.  
Give your answer in standard form, correct to 2 significant figures.

..... [5]

23 This map shows part of a village.

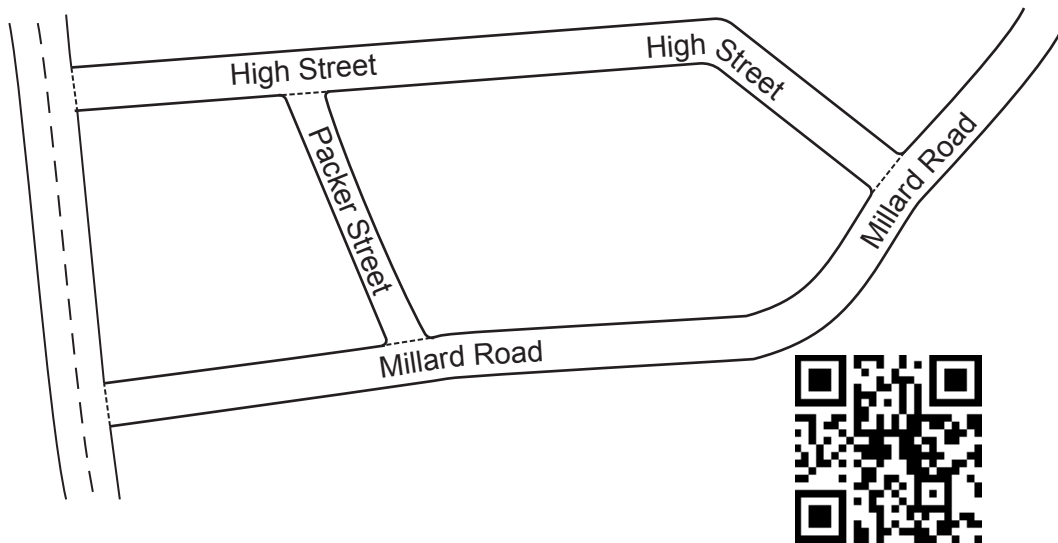

Neil knows that Packer Street is 180m long in real life.

(a) Neil measures the map.

He says

Packer Street is 3.5 cm long.  
High Street is 11.2 cm long.

Therefore, I calculate that High Street is 576 m long in real life.

Use Neil's figures to show that the answer to his calculation is correct.

[3]

(b) Jodie measures the same map.

She says

I think Packer Street is longer than Neil's measurement of 3.5 cm.  
Therefore, High Street must be longer than 576 m in real life.

Is Jodie's reasoning correct?  
Show how you decide.

..... [2]

(c) On another map, Packer Street is 2.4 cm long.

Express the scale of this map in the form 1 :  $n$ .

(c) 1 : ..... [2]

24 These graphs show different relationships between the variables  $x$  and  $y$ .

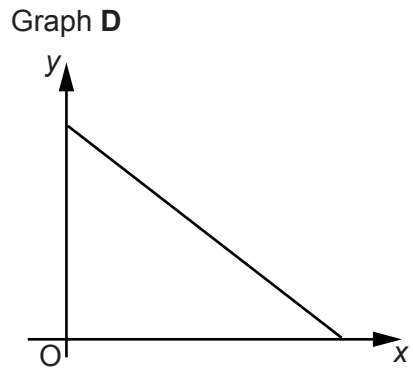
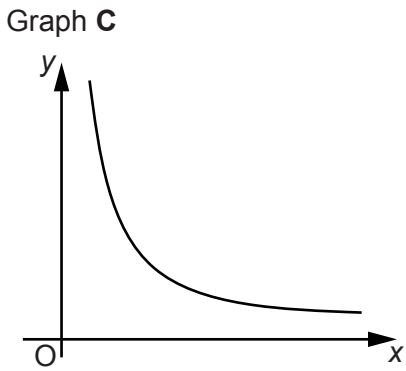
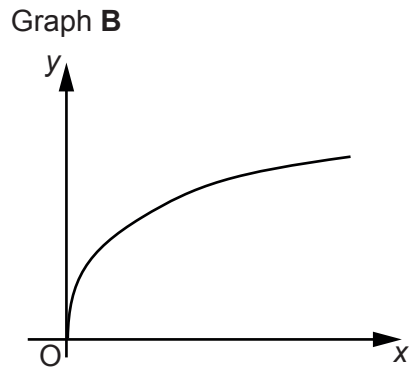
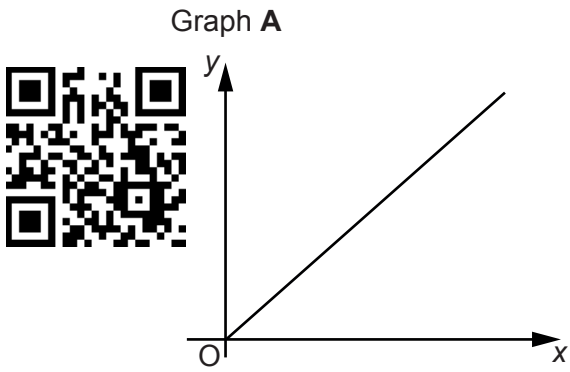

Identify the graph which shows the following.

(a)  $y$  is directly proportional to  $x$ .

(a) Graph ..... [1]

(b)  $y$  is inversely proportional to  $x$ .

(b) Graph ..... [1]

- 25 The diagram shows a square with four identical corners shaded.

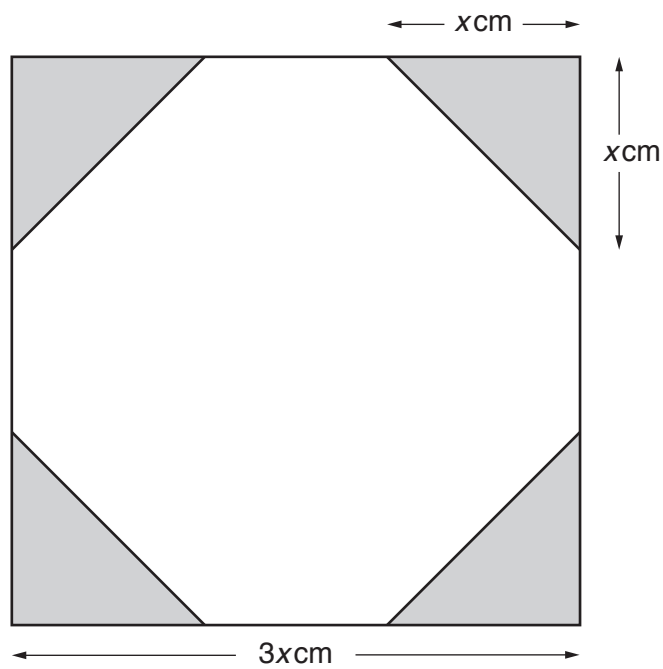

Not to scale

The length of each side of the square is  $3x$  cm.  
The length of each shaded corner is  $x$  cm.

Use this information to show that  $\frac{\text{shaded area}}{\text{unshaded area}} = \frac{2}{7}$ .

Show all your working.

[5]

**ADDITIONAL ANSWER SPACE**

If additional space is required, you should use the following lined page(s). The question number(s) must be clearly shown in the margin(s).

A large rectangular area with a solid vertical line on the left side and horizontal dotted lines across the rest of the page, providing space for writing answers.



**Copyright Information**

OCR is committed to seeking permission to reproduce all third-party content that it uses in its assessment materials. OCR has attempted to identify and contact all copyright holders whose work is used in this paper. To avoid the issue of disclosure of answer-related information to candidates, all copyright acknowledgements are reproduced in the OCR Copyright Acknowledgements Booklet. This is produced for each series of examinations and is freely available to download from our public website ([www.ocr.org.uk](http://www.ocr.org.uk)) after the live examination series.

If OCR has unwittingly failed to correctly acknowledge or clear any third-party content in this assessment material, OCR will be happy to correct its mistake at the earliest possible opportunity.

For queries or further information please contact The OCR Copyright Team, The Triangle Building, Shaftesbury Road, Cambridge CB2 8EA.

OCR is part of the Cambridge Assessment Group; Cambridge Assessment is the brand name of University of Cambridge Local Examinations Syndicate (UCLES), which is itself a department of the University of Cambridge.